

# MICRO SWITCHES



## DS1 SERIES

### SPECIFICATIONS

#### Contact Resistance(initial)

Max. 300 mΩ

Measured by ohm meter - open voltage < 1VDC, driver current -100 mA

#### Insulation Resistance(at 250 VDC / minute)

Min. 100 MΩ

#### Dielectric Strength

250VAC(50~ 60 Hz)

#### Operating Temperature Range

-40°C to 85°C (with no icing)

#### Vibration

10~55 Hz, displacement 0.75 mm(p-p)

#### Electrical Service Life

Min. 5,000,000 operations

#### Electrical Operating Frequency

120 operations per minute

#### Mechanical Service Life

Min. 5,000,000 operations

#### Mechanical Operating Frequency

120 operations per minute

### RATING

0.1A 12VDC , 0.1A 125VAC

### APPLICATIONS

Mouse, Joystick

### DIMENSIONS

Unless otherwise specified, a tolerance of ±0.4mm applies to all dimensions.

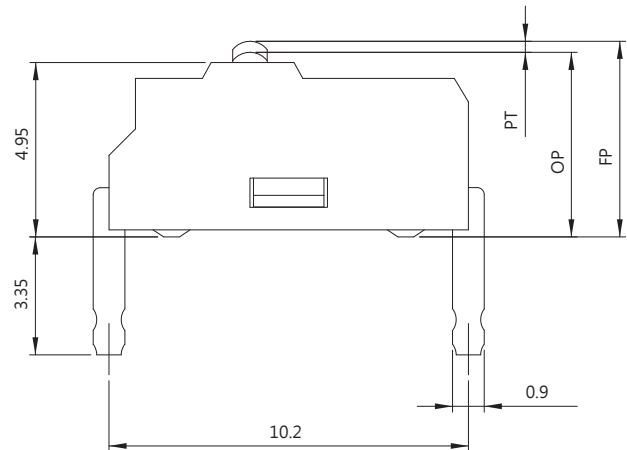
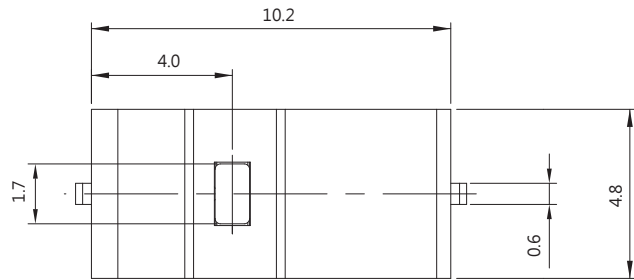

### CONTACT CONFIGURATION

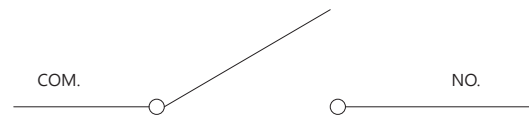

### MOUNTING HOLES

P,C,D Type Terminal

T Type Terminal

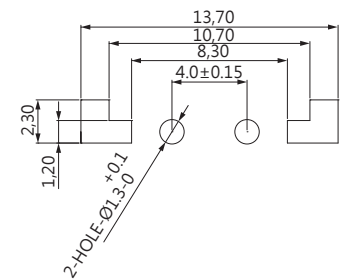
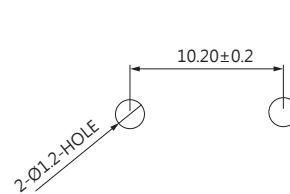

### TERMINAL TYPES

P TYPE

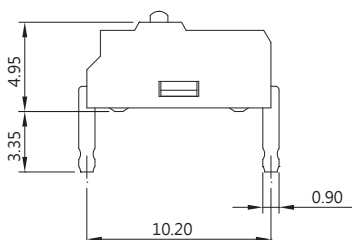

C TYPE

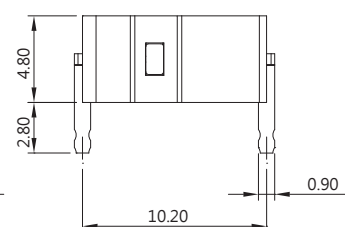

D TYPE

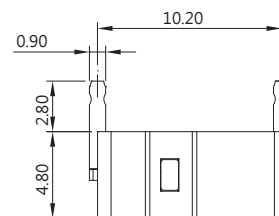

T TYPE

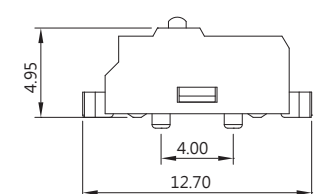

ORDERING INFORMATION

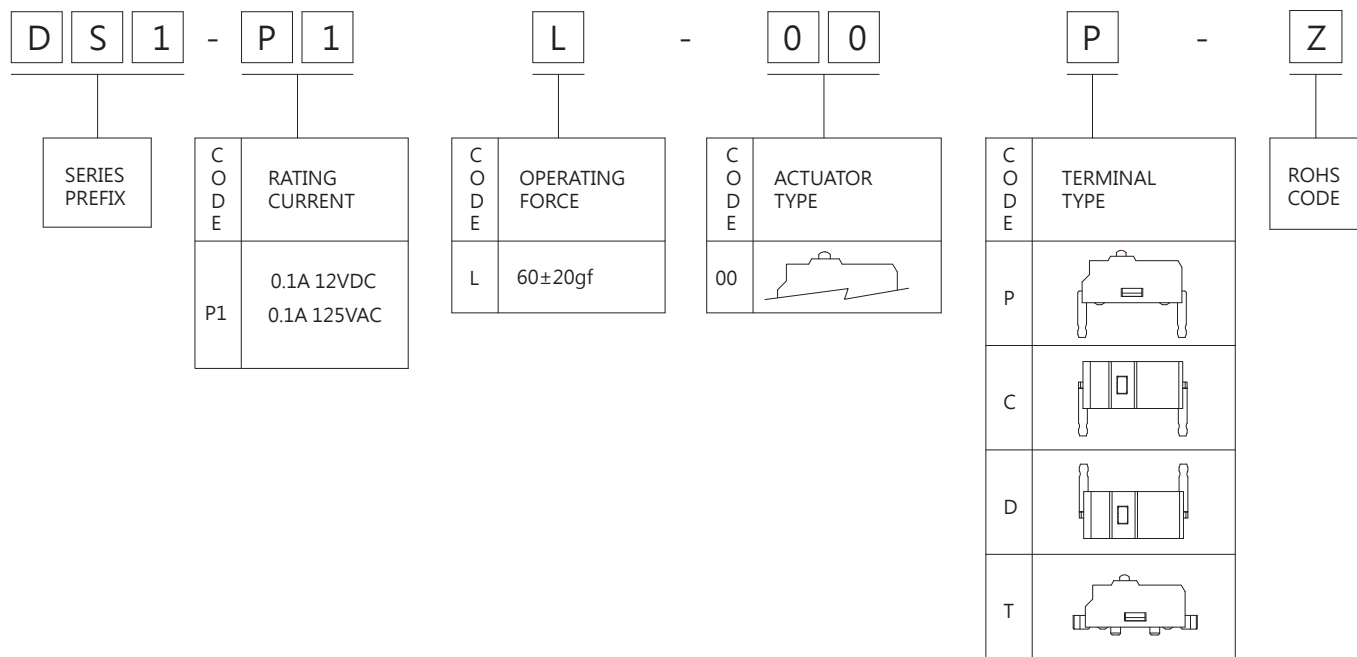

OPERATING CHARACTERISTICS

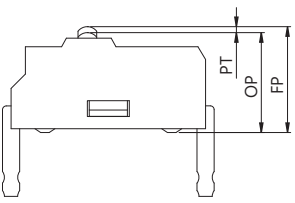
SWITCH TYPE	PART SUFFIX	OF (gf)	OP (mm)	PT Max. (mm)	OT Min. (mm)	MD Max. (mm)	RF Min. (gf)
DS1-P1L-00 □ -Z		L 60±20	5.25±0.2	0.62	0.15	0.12	15