

# WATER PROOF SWITCHES

## DIMENSIONS

Unless otherwise specified, a tolerance of  $\pm 0.4\text{mm}$  applies to all dimensions

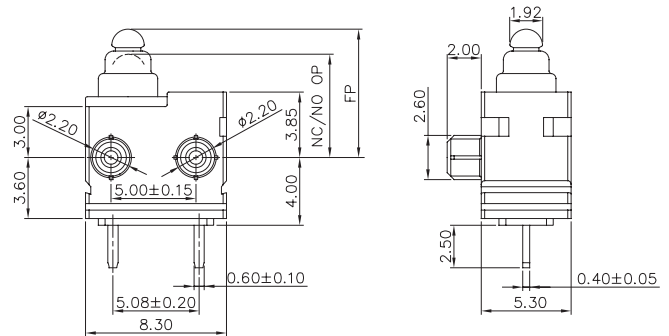

## DW32 SERIES

### SPECIFICATIONS

#### Contact Resistance ( initial )

Max. 500m $\Omega$

Measured by ohm meter –Open Voltage<1VDC, Driver current -100mA

#### Insulation Resistance ( at 100VDC/minute )

Min. 100M $\Omega$

#### Dielectric Strength

Min. 500VAC(50-60HZ)/minute between Live parts.

#### Operating Temperature Range

-40°C to 85°C ( with no icing )

#### Vibration

10~55Hz, displacement 0.75 mm (p-p)

#### Electrical Service Life

50mA 16VDC- Min. 150,000 operations

50mA 12VDC- Min. 200,000 operations

0.1A 12VDC- Min. 300,000 operations

1mA 5VDC- Min. 300,000 operations

#### Electrical Operating Frequency

Max. 120 operations per minute

#### Operating application of the switch

Set the switch pushing distance from 60% to 90% of the specified OT value

#### APPLICATION

Automobiles

(detection of door opening and closing and shift lever position, etc.)

Household appliances

(propane stoves, vacuum cleaners, air conditioners Washing machines, etc.)

### CONTACT CONFIGURATION

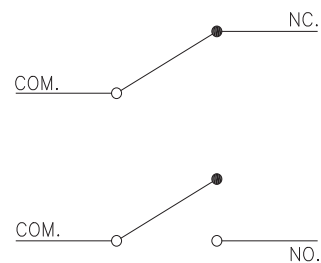

### MOUNTING HOLES

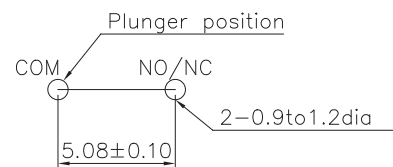

### ORDERING INFORMATION

DW32	P1	S	00	YC	1	A	0A	Z
SERIES PREFIX	RATING CURRENT	OPERATING FORCE	ACTUATOR TYPE	TERMINAL TYPE	CIRCUIT ARRANGEMENT	PILLAR TYPE	SPECIAL CODE	ROHS CODE
	50mA 16VDC 50mA 12VDC 1mA 5VDC Contact Plated Silver	S STANDARD	00 01	A P EC ED YC YD	1 S.P.S.T-NO. 2 S.P.S.T-NC.	A		

CODE	L1	H	#A	#B	C	D	P
A	2.0	3.85	2.2	2.2	2.6	2.6	5.0

TERMINAL TYPES( THE thickness of each terminal is 0.4 mm )

A TYPE

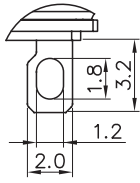

E- TERMINAL C TYPE

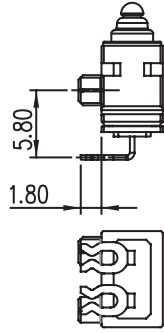

E- TERMINAL D TYPE

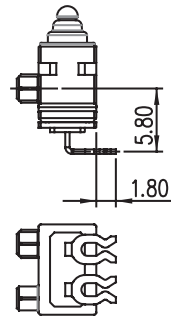

P TYPE

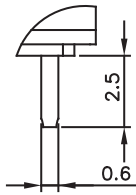

Y- TERMINAL C TYPE

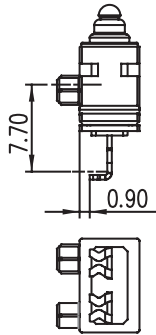

Y- TERMINAL D TYPE

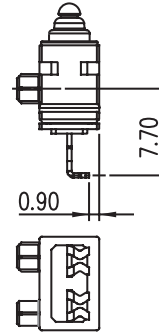

COVER TYPES ( PILLAR & TRAVEL TYPES )

A TYPE

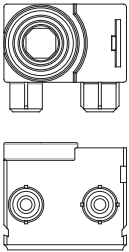

OPERATING CHARACTERISTICS

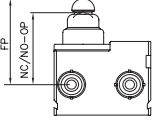
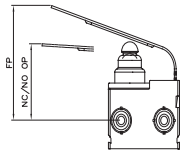
SWITCH TYPE	PART SUFFIX	OF Max ( gf )	FP Max ( mm )	NC/NO-OP ( mm )	NC/NO-OT Min.( mm )	
DW32- □□ -00 □□ -Z		S	122	7.7	7.1±0.25	1.75
DW32- □□ -01 □□ -Z		S	122	12.0	8.3±1.25	0.4

### Correct Use :

1. Do not handle the Switch in a way that may cause damage to the sealing rubber.
2. When handling the Switch, ensure that pressure is not applied to the posts in the directions shown in the following diagram.

(hatch part (both sides) shown below) of the switch in the direction indicated by the arrows.

Also, ensure that uneven pressure or pressure in a direction other than the operating direction is not applied to the Actuator as shown in the following diagram. Otherwise, the post, Actuator, or Switch may be damaged, or the service life may be reduced.

