

# MICRO SWITCHES

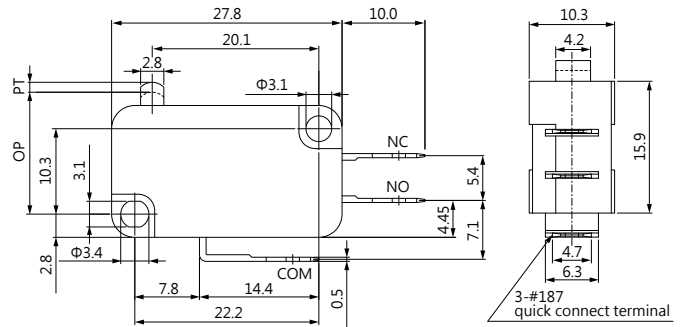

## DIMENSIONS

Unless otherwise specified, a tolerance of  $\pm 0.4\text{mm}$  applies to all dimensions.



## VMN SERIES

### SPECIFICATIONS

#### Contact Resistance(initial)

Max. 100 m $\Omega$

Measured by ohm meter - open voltage < 1VDC, driver current -100 mA

#### Insulation Resistance (at 500 VDC / minute)

Min. 100 M $\Omega$

#### Dielectric Strength

1000 VAC(50~ 60 Hz)

#### Storage Temperature Range

-25°C to 85°C (with no icing)

#### Storage Humidity

At 40°C , Max. 85% R.H

#### Operating Temperature Range

-40°C to 125°C (with no icing)

#### Vibration

10~55 Hz, displacement 0.75 mm(p-p)

#### Electrical Service Life

0.1A - Min. 1,000,000 operations

Other ratings - Min. 10,000 operations

#### Electrical Operating Frequency

0.1A-120 operations per minute

Other ratings-10~30 operations per minute

#### Mechanical Service Life

Min. 10,000,000 operations

#### Mechanical Operating Frequency

120 operations per minute

### APPLICATIONS

Joystick, TV game, Time Recorder, Air Conditioner, Food Processor, Juice Maker, Alarm, Mixer, Shredder Machine.

### CONTACT CONFIGURATION

0 : S.P.D.T

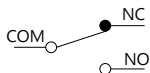

1 : S.P.S.T.NO

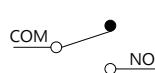

2 : S.P.S.T.NC

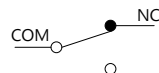

### MOUNTING HOLES

2- $\varnothing 3.1$  mounting holes  
or M3 screw holes

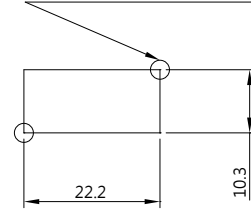

### CERTIFICATE INFORMATION

Model Name	UL	ENEC14
VMN-P1	0.1A 125/250VAC (Temp:120°C) Min. 6,000 operations	0.1A 125/250VAC, $\mu 40T125$ , 1E4
VMN-03	3A 125/250VAC (Temp:85°C) Min. 6,000 operations	3A 125/250VAC, $\mu 40T125$ , 1E4
VMN-06	6A 125/250VAC (Temp:55°C) Min. 6,000 operations	6A 125/250VAC, $\mu 40T125$ , 1E4
VMN-T6S	6A 125/250VAC (Temp:200°C) Min. 6,000 operations	Non
VMN-10	10.1A 125/250VAC Min. 6,000 operations	10A 125/250VAC, $\mu 40T125$ , 1E4
VMN-15	15A or 1/2HP 125/250VAC (Temp:120°C) Min.10,000 operations	15A 125/250VAC, $\mu 40T125$ , 1E4 or 16(4)A 125/250VAC, $\mu 40T125$ , 1E4

### THE SELECTION OF RATING & FORCE

MODEL	Rating	B	D	N	L	S	H	SPECIFY H
VMN	0.1 A	*	*	*	*	*	*	*
	3 A		*	*	*	*	*	*
	6 A			*	*	*	*	*
	10 A			*	*	*	*	*
	15 A					*	*	*
	16 A, 16(4) A							*

NOTE : The Symbol " \* " to represent the result is accepted

TERMINAL TYPES

Solder terminal A TYPE

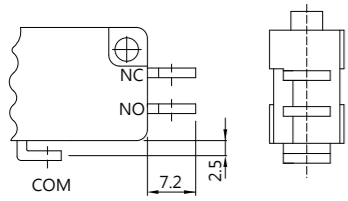

Screw terminal B TYPE

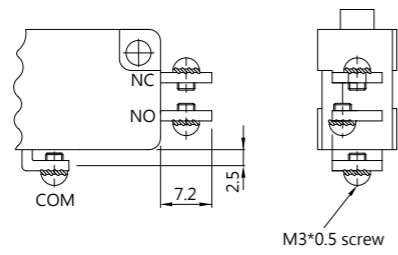

Quick connect terminal 250 Series C TYPE

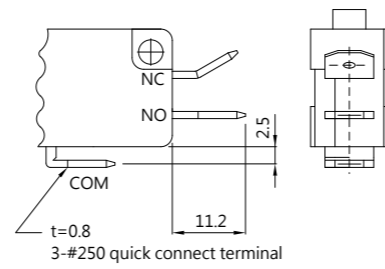

Quick connect terminal 187 Series D TYPE

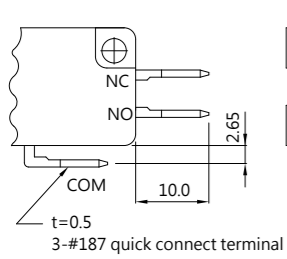

Quick connect terminal 250 Series E TYPE

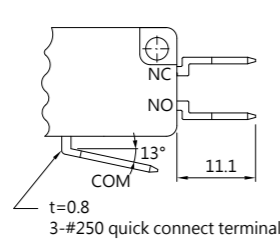

Quick connect terminal 250 Series F TYPE

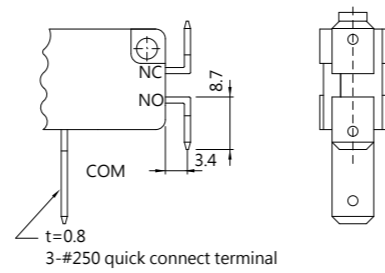

Quick connect terminal 250 Series G TYPE

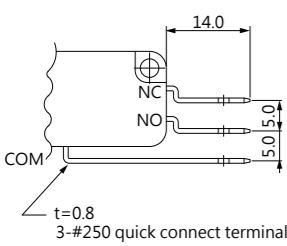

PCB terminal K TYPE

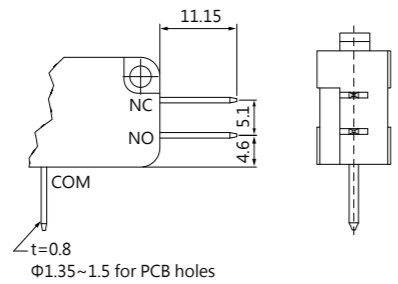

PCB terminal P TYPE

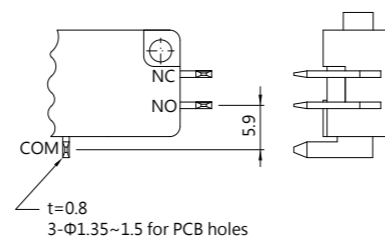

ORDERING INFORMATION

V	M	N	-	0	6	H	-	0	3	D	0	-	B	-	Z
SERIES PREFIX	C O D E	RATING CURRENT	C O D E	OPERATING FORCE	C O D E	ACTUATOR TYPE	C O D E	TERMINAL TYPE	C O D E	CIRCUIT ARRANGEMENT	C O D E	COLOR	ROHS CODE		
P1	01	0.1A;125/250 VAC	B	8.4	00		A	SOLDER TERMINAL (A)	0	S.P.D.T	B	BLACK			
03	02	3A;125/250 VAC	D		01		B	SCREW TERMINAL (B)	1	S.P.S.T. NO					
06	03	6A;125/250 VAC	N		02		C	250 SERIES (C)	2	S.P.S.T. NC					
10	04	10A;125/250 VAC	L		03		D	187 SERIES (D)							
15	05	15A,16(4);125/250 VAC	S		04		E	250 SERIES (E)							
16A	06	16A;125/250 VAC	H		05		F	250 SERIES (F)							
			A				P	PCB TERMINAL (P)							
			C				G	250 SERIES (G)							
			M	14.2			K	PCB SERIES (K)							
			R												
			G												

OPERATING CHARACTERISTICS

SWITCH TYPE	PART SUFFIX	OF Max. (gf)						OP (mm)	PT Max. (mm)	OT Min. (mm)	MD Max. (mm)	
		B	D	N	L	S	H					
VMN- □□□ -00 □□ -B-Z		B	D	N	L	S	H	SPECIFY H	14.7±0.5	1.72	0.8	0.25
		18	45	75	110	170	230	330				
VMN- □□□ -01 □□ -B-Z		B	D	N	L	S	H	SPECIFY H	15.3±0.5	1.57	0.6	0.41
		18	45	75	110	170	230	330				
VMN- □□□ -02 □□ -B-Z		A	C	M	K	R	G	SPECIFY G	15.3±1.1	2.85	1.55	0.5
		8	27	43	50	85	120	175				
VMN- □□□ -03 □□ -B-Z		B	D	N	L	S	H	SPECIFY H	15.3±1.5	3.18	1.60	0.76
		8	22	37	50	86	125	180				
VMN- □□□ -04 □□ -B-Z		A	C	M	K	R	G	SPECIFY G	15.3±2.3	5.60	3.10	1.02
		5	16	22	30	51	65	90				
VMN- □□□ -05 □□ -B-Z		B	D	N	L	S	H	SPECIFY H	15.3±2.5	7.60	3.00	1.2
		6	13	25	30	49	70	120				
VMN- □□□ -06 □□ -B-Z		A	C	M	K	R	G	SPECIFY G	15.3±4.3	10.0	5.00	1.70
		-	8	15	20	30	35	50				
VMN- □□□ -07 □□ -B-Z		B	D	N	L	S	H	SPECIFY H	18.7±1.5	3.18	1.40	0.76
		10	28	43	65	110	140	205				
VMN- □□□ -08 □□ -B-Z		A	C	M	K	R	G	SPECIFY G	18.7±2.1	5.60	2.55	1.02
		7	16	24	35	56	70	100				
VMN- □□□ -09 □□ -B-Z		B	D	N	L	S	H	SPECIFY H	20.7±0.8	1.72	0.60	0.25
		20	55	80	110	170	230	330				
VMN- □□□ -10 □□ -B-Z		A	C	M	K	R	G	SPECIFY G	20.7±1.1	2.50	1.40	0.40
		8	35	55	70	100	120	175				
VMN- □□□ -11 □□ -B-Z		B	D	N	L	S	H	SPECIFY H	20.7±1.5	3.18	1.60	0.76
		8	30	50	65	100	125	180				
VMN- □□□ -12 □□ -B-Z		A	C	M	K	R	G	SPECIFY G	20.7±2.2	5.08	2.80	1.02
		7	20	30	40	51	65	90				